

**SYNCHRONIZED PHASOR MEASUREMENTS**  
**~ Measurement techniques, Applications, and Standards**

**A.G. Phadke**  
**Virginia Tech, Blacksburg, Virginia**  
**USA**

**SUMMARY**

Synchronized phasor measurements have been a revolutionary measurement technique for electric power networks which is being adopted by most electric utilities around the world. This technique is able to obtain the state of the power system directly by measurement, and hence the best application of this technique is in state estimation in the Energy Management Systems. In addition, the technique offers real time information about the network which can be used in special protection and control function. Because the feed-back is provided from remote locations, it is no longer necessary to obtain an accurate model of the power system for designing adaptive protections and optimal control systems. The technology has matured to a point where industry standards are available to make the units of different manufacture interoperable.

**KEYWORDS**

Synchronized phasor measurements, PMU, real-time, protection, control, phasors, GPS, SIPS, RAS, SPS, feed-back, IEEE, Standards,.

## INTRODUCTION

Synchronized phasor measurements across the entire power system have been made possible by the availability of Global Positioning System (GPS) time tags, and by the computer based phasor measurement technology developed first in the digital relaying field. In fact, it is fair to state that the modern phasor measurement systems can trace their origin to the development of the Symmetrical Component Distance Relay (SCDR) in the early 1970s. [1] In those days, the microcomputers available for relaying were not capable enough to handle the requirements of a distance relay algorithm. This led to the invention of a new relaying principle (SCDR) which used symmetrical components of voltages and currents in order to convert the 6 fault equations of a three phase transmission line into a single equation using symmetrical components. Over time it became clear that microcomputers have become sufficiently capable so that this innovation is no longer so attractive for line relaying. However, the fact that the SCDR utilized efficient methods of measuring symmetrical components of voltages and currents proved to be very interesting for other applications. In fact, positive sequence voltages and currents of a network are extremely useful in most of the power system analysis programs: load flow, stability, short circuit, optimum power flow, state estimation, contingency analysis, etc.

In early 1980s GPS satellites were being deployed in significant numbers, and it became clear to us that using GPS time signals as inputs to the sampling clocks in the measurement system of digital relays one would have a very powerful measurement tool, which would be able to provide instantaneous picture of the state of the power system, and in fact would have many outstanding features which would make these measurements become effective immediately even if complete observability of the network could not be achieved with the new measuring devices.

## HISTORICAL DEVELOPMENTS

Wide area measurements are not new to the field of power system engineering. In the early 1940s a system of wide area measurements were deployed on most modern power systems in order to achieve regulated frequency of the network and controlling the power flow over tie lines so that they remained on schedule. This is the system of ‘tie-line-bias-control’ which is in use in some form throughout the world. [2] Figure 1 shows the basic arrangement of this scheme. Tie line flows are metered and brought to the Energy Management Center (EMC) where the Area Control Error is calculated using locally measured frequency.

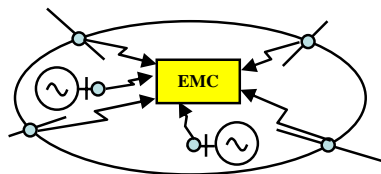

**Figure 1:** The first modern wide area measurement system used to control interconnected system frequency, tie line flows, and achieve economic dispatch of generators.

The start of the modern EMS systems based upon state estimators can be said to have begun with the aftermath of the 1965 catastrophic failure of the North-Eastern power grid in North America. There was a great deal of research conducted in techniques for determining the state of the power system in real time based upon real-time measurements. Of course, there was not the possibility of achieving synchronized measurements in those days, and instead a technique was devised whereby measurements could be obtained by sequential scan and from them the state of the power system estimated by a non-linear state estimator. Of course the state obtained consisted of positive sequence voltages at all the network buses, and it was recognized that the state obtained in this manner at best described a quasi-steady state approximation to the actual state of the network.

The author of the present paper moved to Virginia Tech in Blacksburg, VA in 1982, and he, his colleagues, and his students began systematic development of synchronized Phasor Measurement Units (PMU) using the GPS transmissions to synchronize the sampling clocks, so that the calculated phasors could be put on a common axis of reference. The first PMUs developed in the Power System Research Laboratory of Virginia Tech are shown in Figure 2.

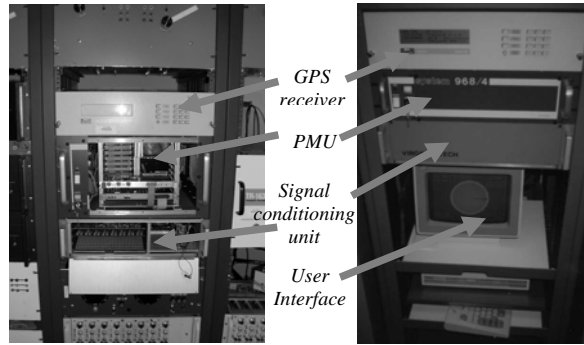
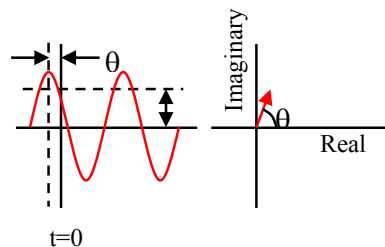

**Figure 2:** The first experimental PMUs developed at Virginia Tech in 1980s

The GPS receivers of those days had very precise crystal clocks internal to the receivers, so that when the GPS signals were not available due to incomplete deployment of the satellite system, the clocks could keep the time accurate until the next availability of the GPS satellite signals. These units were quite expensive ~ of the order of 25,000 US dollars per unit. Today, with the satellite system complete and fully deployed, a chip set of the GPS receivers could be obtained for just a few hundred dollars!

### MEASUREMENT TECHNIQUES

The basic definition of the phasor representation of a sinusoid is illustrated in Figure 3. Assume a single frequency constant sinusoid of frequency  $\omega$  is observed starting at time  $t=0$  as shown in the figure. The sinusoid can be represented by a complex number called ‘Phasor’ which has a magnitude equal to the root-mean-square (rms) value of the sinusoid, and whose angle is equal to the angle between the peak of the sinusoid and the  $t=0$  axis.

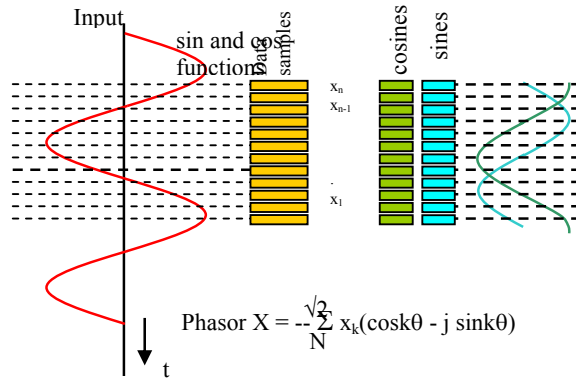

**Figure 3:** Definition of a Phasor, a complex number representation of a constant pure sinusoid.

It is recognized that waveforms found in a power system are rarely pure sinusoids, neither are they constant. For our purposes, the definition of the phasor is applied to the waveform observed in an “observation window”, and it is assumed that outside the window the sinusoid is continuous and unchanging. If the sinusoid is not a pure sine wave, the phasor is assumed to represent its fundamental frequency component calculated over the data window.

The most commonly used method of calculating phasors from sampled data is that of Discrete Fourier Transform (DFT). This is illustrated in Figure 4. Data is sampled at a constant clock rate providing a fixed number of samples in one period of the input signal. In practice the sampling clocks are usually kept at a constant frequency even though the input signal frequency may vary by a small amount around its nominal value. A secondary correction must be applied to the estimated phasor when the signal frequency deviates from its nominal value. However, the reader is referred to published literature for details about these corrections.[3]

The phasor calculation is continuous as more data is obtained as time advances. One could start a new phasor calculation each time a new sample is obtained by initializing the DFT process to a new data window.



**Figure 4:** Estimation of phasors from sampled data using Discrete Fourier Transform.

A more computationally efficient method is to update the estimated phasor by adding the contribution made by the new sample, and subtracting the contribution made by the oldest sample. This is illustrated in Figure 5. An artifact of the recursive DFT algorithm is that the constant sinusoid of nominal frequency produces a constant phasor. The recursive phasor estimator is numerically unstable: any error made in a computation is never eliminated from the result. In integer arithmetic the round-off error is such that if care is not taken the accumulated error soon wipes out the actual phasor estimate. In this sense the non-recursive phasor estimation is to be preferred. However, even for the recursive phasor estimation it is possible to safeguard against error accumulation by careful programming.[4]

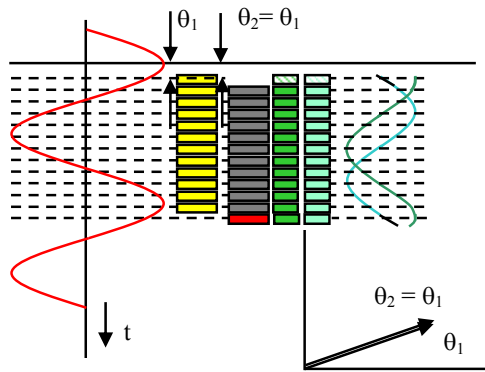
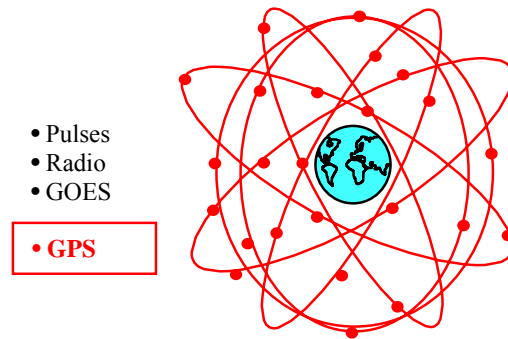

**Figure 5:** Recursive estimation of phasors from sampled data with moving window DFT.

### PHASOR MEASUREMENT UNIT

The modern PMUs use one pulse per second signals provided by the GPS satellite receivers. It should be noted that earliest experiments with achieving synchronized measurements used a variety of methods: transmitted synchronizing pulses, radio signals, GOES satellites, etc. However, beginning in early 1980s it became clear that the GPS system (see Figure 6) provides the most reliable and accurate method of sampling clock synchronization.

The accuracy of the GPS timing pulse is better than 1 μs, which for a 60 Hz system corresponds to about 0.02 degrees. This accuracy is more than enough to ensure that the measurements obtained by such clocks will be simultaneous for the purpose of estimation and analysis of the power system state.



**Figure 6:** GPS satellite transmissions as the preferred method of achieving synchronization of sampling clocks in PMUs.

A functional block diagram of a PMU is shown in Figure 7. The analog signals are filtered for avoiding electro-magnetic interference, and further filtered for anti-aliasing purposes. The GPS 1 pps signal is used in a phase locked loop to create the sampling clock pulses, which are then used for sampling the analog signals. The sampled data are processed by the recursive DFT algorithms to calculate phasors of phase voltages and currents. The DFT calculation is usually based on a one cycle data window. The calculated phasors are combined to form positive sequence measurements, and time-tagged with the timing information provided by the clock and the Second of Century (SOC) count provided by the GPS receiver. In the most recent version of the Synchrophasor standard (described in a later section) the time tags will be aligned with multiples of nominal power frequency periods, with the fastest reporting rate corresponding to two periods. The standard also defines format for the transmitted data files.

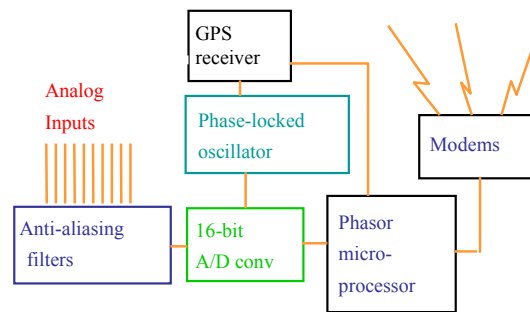

**Figure 7:** Functional block diagram of the elements in a Phasor Measurement Unit. The general structure is similar to many power system relays and digital fault recorders.

## STANDARDS

There are two IEEE standards which are relevant to the present subject. The first one is a general transient data recording file format standard called ‘COMTRADE’, and the second is the standard applicable to the PMU technology: ‘SYNCHROPHASOR’.

Both these standards were created by the same experts who were active in the field of computer relaying and later in phasor measurement technology. The COMTRADE standard has its origin in a working group report of CIGRE study committee SC34. In an appendix to that report the basic structure of this standard was developed. Later IEEE formed a working group to create the standard under the Chairmanship of the present author, and the standard has now been revised and simultaneously accepted as an IEC standard.

## COMTRADE

### 1. Historical Background

- CIGRE WG 34.01, A.G. Phadke, Convener
- Scope of WG Report
- CIGRE and standards
- Genesis of COMTRADE

### 2. IEEE Working Group PSRC H-5

- Formed in 1988-89
- Common membership and Chair with CIGRE 34.01
- Assignment: to create an IEEE Standard

**Figure 8:** Genealogy of the COMTRADE standard.

The COMTRADE standard is designed to serve the purpose of facilitating the transfer of data between transient data creating facilities, and those involved in using those data. It had been observed in the past that each computer relay, digital fault recorder, and other substation data collection equipment utilized proprietary data structures, and this made using these data cumbersome when many parties had an interest in using the data. During early years of computer relaying development this interest was directed towards editing the data and processing it in word processors. It was therefore agreed that the COMTRADE standard would be an ASCII format standard. However, with the revision cycle it became clear that there was greater interest in keeping the data files small in size, and hence binary data files are also accepted in the most recent version of COMTRADE. The general concept of compatible data files in this format is illustrated in Figure 9.

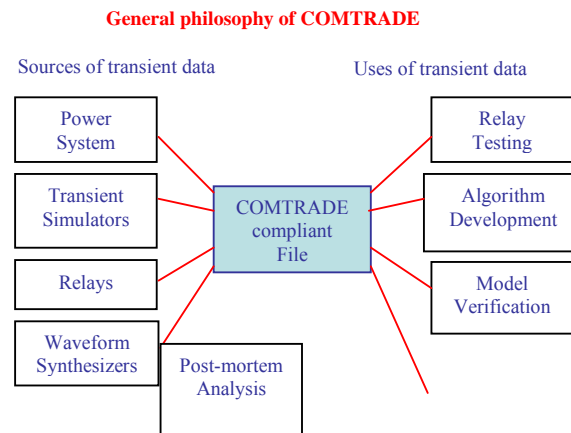

**Figure 9:** Relationship between producers and users of transient data and the COMTRADE standard.

The SYNCHROPHASOR standard was motivated by the wish of PMU users to have interoperability of PMUs made by different manufacturers. This standard is based upon the COMTRADE standard, and was formulated by experts in the Power System Relaying Committee of IEEE Power Engineering Society ~ see Figure 10(a).

### IEEE standard for SYNCHROPHASORS for Power Systems

**IEEE Std 1344-1995**  
**IEEE Power Engineering Society**  
**Sponsored by the**  
**Power System Relaying Committee**

**Figure 10(a):** The SYNCHROPHASOR standard sponsoring organization.

The SYNCHROPHASOR standard provides the definition of the file format for the phasor data transfer from PMUs to a central location. It is accepted that here the main interest will be in high speed data transmission, and hence only binary data format is allowed. In addition to the real and imaginary components of the measured phasors, the standard also allows space for transmitting the calculated frequency and rate of change of frequency as observed locally at the substation. Besides the phasor data, the standard also allows space for network topology information as provided by the switch and breaker status in the substation. As in case of the COMTRADE standard, there is a time tag which identifies the instant when the phasor is measured. As mentioned before, the time tag consists of the SOC and sample number which falls on the reporting cycle boundary. It is permitted that the data be made available at intervals which may be as fast as once every two cycles of the power frequency, and could be slower as defined in the standard.

DATA format for communication interface

Files for transmission in an off-line mode.

Header File:  
ASCII file describing data.

Configuration File:  
Machine readable binary file describing the data.

*Figure 10(b): Main elements of the SYNCHROPHASOR file structure.*

Figure 10(b) identifies two files which are provided in addition to the data files by the SYNCHROPHASOR standard. The Header file is an optional ASCII file which provides general information about where the data is collected, while the Configuration file is a required machine readable file describing the what is contained in each of the data columns. The latest revision of this standard (C37.118) has just been issued by IEEE (March 2006).

#### APPLICATIONS ~ STATE ESTIMATION

Modern state estimation techniques were developed in 1970s. Clearly at that time there was no hope of measuring synchronized positive sequence voltages directly. The techniques that evolved depended upon measuring active and reactive power flows and voltage magnitudes at substations, and then communicating them to a central site for processing.

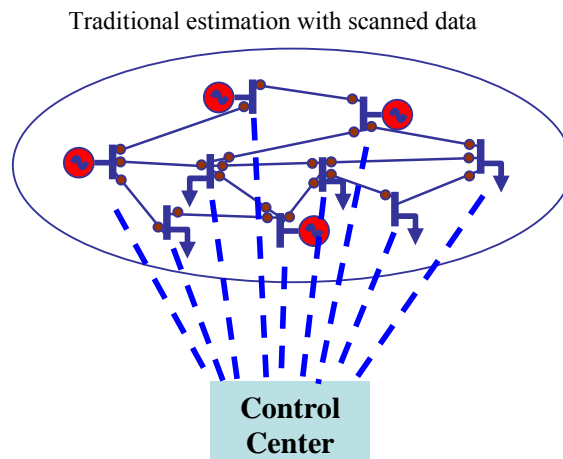

**Figure 11:** State estimation formalism in traditional methods using scanned data and non-linear state estimation algorithms.

This is still the technology in use today in most power systems. The fact that the data is scanned over a considerable period (seconds to minutes) means that the calculated state is at best an approximation to averaged system state. The slow scan rates, and the time consumed in performing non-linear iterations make the estimated state available at intervals of the order of seconds or minutes, and hence only steady-state type of system phenomena could be observed and controlled by the state estimators of this vintage.

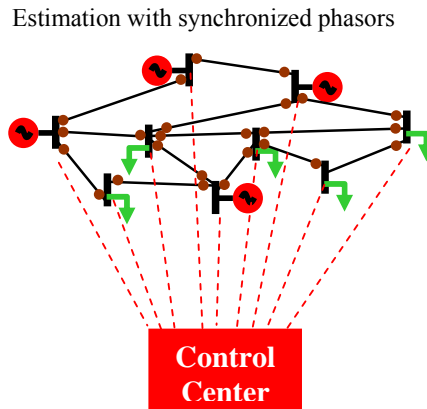

**Figure 12:** State estimation formalism for using time synchronized PMU measurements to provide linear state estimation algorithms.

The synchronized phasor measurements measure the positive sequence bus voltages (and currents) directly, and hence it is clear that they are a natural vehicle for state estimation or state measurement applications. Their use for state estimation is schematically shown in Figure 12. If there is no existing state estimation software in an EMS center, and one is being considered for installation, it is obvious that the method of choice would be to use PMU data for this purpose. Positive sequence voltage and currents readily lead to a linear state estimator, and redundancy and bad data can be handled in usual ways. It is interesting to note that PMU data can be flagged at source for certain sources of error, such as loss of synchronism.

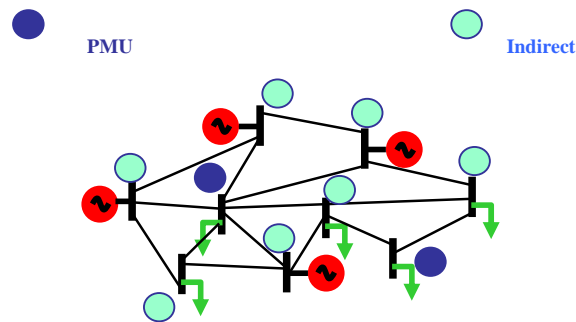

**Figure 13:** Current measurements used to provide indirect voltage measurements.

The PMU data is generally available at very frequent intervals (of the order of every few cycles), hence it is often possible to track dynamic phenomena taking place on the power system, and possibly taking part in controlling them with real-time feed-back. This is discussed in the next section.

Another feature of the PMU measurements is that it is not necessary to have a completely observable network before state estimation could be performed. It is frequently possible to just take a



few phasor measurements from key locations on the network, and use these measurements to provide valuable information to control centers or network controlling devices. Also, it is possible to divide the power system in observable and unobservable islands, and from the observable islands make close estimates of the unobserved portions. This is illustrated in Figure 14.

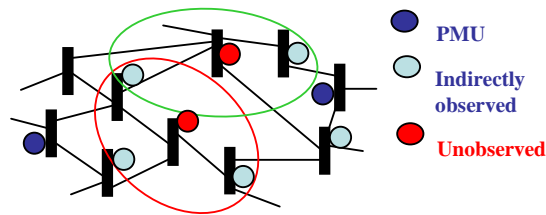

**Figure 14:** Estimators for incomplete observability.

This concept has been developed as unobservable islands with a specific ‘depth’ of unobservability. [5] The greater the allowed depth, fewer the number of PMU measurements needed. This idea is useful in developing an implementation strategy for a power system with slowly increasing number of PMUs being installed over an extended period. The results of such an analysis are shown in Table I.

**Table I**  
PMUs required for covering a power system with variable depths of inobservability

Test System	Size (Buses/Lines)	Complete Observability	Incomplete Observability		
			Depth		
			1	2	3
IEEE 14 Bus	(14,20)	3	2	2	1
IEEE 30 Bus	(30,41)	7	4	3	2
IEEE 57 Bus	(57,80)	11	9	8	7
System $\alpha$	270,326)	90	62	56	45
System $\beta$	444,574)	121	97	83	68

Another interesting aspect of the state estimation problem is the issue of combining phasor measurements with traditional P,Q measurements in a hybrid state estimator. In this instance, it is possible to combine all the measurements in one set, and develop a hybrid non-linear state estimator. In more recent work, an alternative approach has been suggested where it is possible to retain the traditional state estimator software intact, and add the phasor measurements in a linear post-processing step. It has been shown that the two methods provide the same results, and the alternative suggested here is computationally more attractive.

## APPLICATIONS ~ CONTROL

The idea of using phasor measurements to improve control of power system elements has been investigated for a number of years. A modern power system has many controllable elements available: for example generator excitation, governor controls, static var controllers, etc. Each of these controllers is required to achieve a control objective which is global in nature: for example an HVDC controller may be called upon to damp electromechanical oscillations between two widely separated areas of a power system. In such cases, in the past technology no possibility exists of obtaining direct measurements of the global phenomena to be controlled, and the only available tool is to develop a mathematical model of the global phenomenon and see how it is reflected in local measurements.

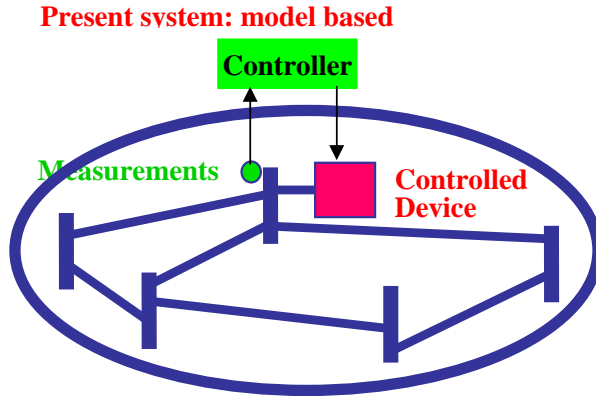

*Figure 15: Model based controllers.*

To the extent that such modeling is accurate, one could then use the local measurements for feedback in the controller. However, it is known that the power system is a highly non-linear system, with attendant difficulties in developing models which are valid for wide ranging system conditions. It is therefore recognized that such controllers are rarely optimum, and may in fact produce completely unacceptable responses to system phenomena.

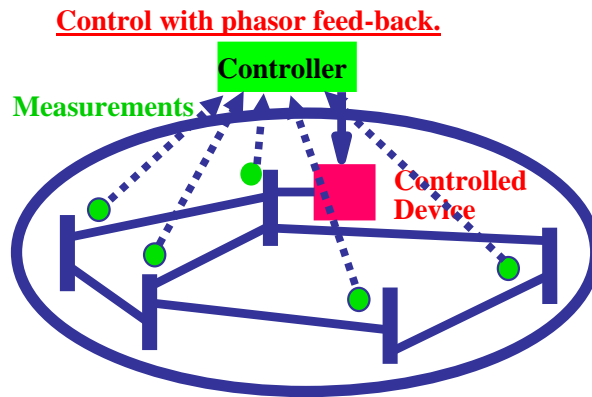

*Figure 16: Controllers with phasor feed-back.*

The high-speed synchronized phasor measurements provided by PMUs offer a very attractive alternative to the problem of power system controllers. Remote measurements could be brought to the controlled device at high speed, and the remote inputs used as feed-back signals in the controller. Such controllers have been studied for controlling power system stabilizers, excitation systems of generators, HVDC terminals, and FACTS devices. [6,...12] A representative scheme of such controllers is shown in Figure 17.

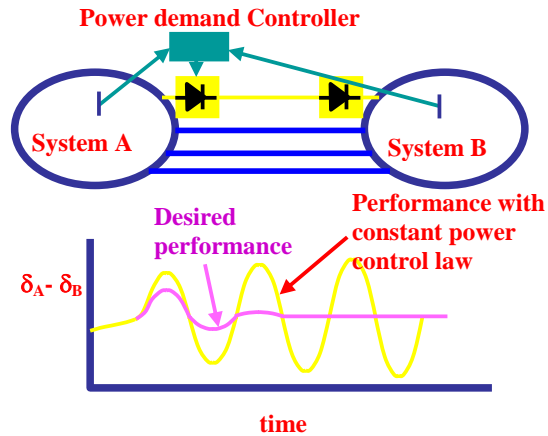

Figure 17: Conceptual formulation of an optimal controller using phasor feed-back.

### APPLICATIONS ~ PROTECTION

In recent years, a number of blackouts in power networks throughout the world have focused attention on the performance of protection systems when the power system is stressed. It is observed that many settings made in protection systems are based upon assumed network conditions and contingencies. When actual network contingencies occur, often the network is not in a state which has been assumed, neither is the contingency one which has been anticipated during the design phase.

#### ● Controlled Security & Dependability

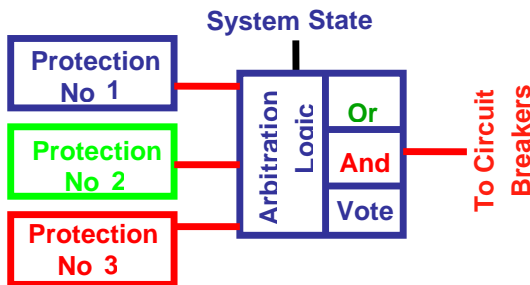
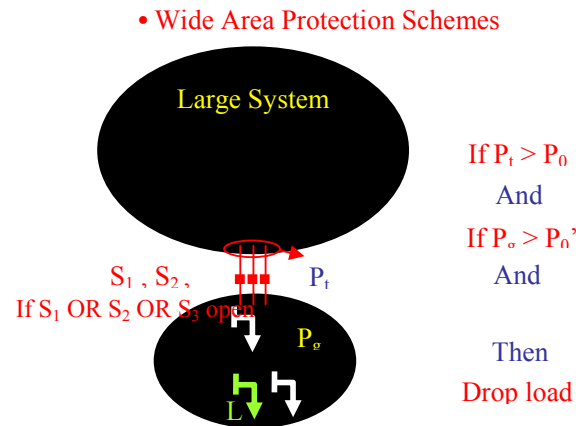

Figure 18: Adaptive control of security and dependability of a protection system.

In particular, it has been found that many protection systems trip in unexpected manner (over-trip) when the power system is undergoing a catastrophic disturbance. This is partially due to the bias in protection systems as they are normally designed in favor of dependability, and in so doing the security is sacrificed to a certain extent. A highly dependable protection system is desirable when the power system is in a normal (un-stressed) state, but when the same system become stressed, it would be desirable to have the protection system become more secure – meaning that one would accept the slightly increased probability that the protection system would not trip for some fault, with the increased probability that it would not produce a false trip. Such a control of dependability and security of a power system is shown schematically in Figure 18. The state of the power system is assessed based upon the wide area measurements provided by the PMUs, and when it is determined that the power system is in a stressed state, at key locations on the network the protection system is made more secure by requiring a vote among several relays to confirm that a fault exists before it is allowed to trip. Some power companies have in fact adapted such voting schemes at their key installations.

This controlled dependability-security system is an example of Adaptive Relaying. Other adaptive relaying applications include distance relay zone adjustments, transformer protections, reclosing operations, out-of-step relays, etc. This is an important area of development in modern protection system theory.



**Figure 19:** Representative Remedial Action Scheme based on wide area measurements and protection principles.

Another popular innovation in modern protection systems is the increasing use of Remedial Action Schemes (RAS), now re-named System Integrity Protection Schemes (SIPS). These schemes use wide area measurements to identify system conditions under which extra-ordinary actions must be taken to avoid major system outages. Many such systems are in existence throughout the world, and Figure 19 shows an example of such a scheme. This is a load shedding scheme which takes action if certain loading conditions are met, and an important tie line is lost. It is known from system studies carried out over extensive loading and contingency scenarios that under these conditions, if the load is dropped, the system would survive, while if it is not dropped the system would go into a blackout.

It should be noted that systems of this nature combine many ideas of protection principles, control principles, and make use of wide area measurements. With PMU data available at a very rapid rate, it becomes possible to invoke more sophisticated triggering conditions for SIPS systems. In addition to load levels, one could imagine using phase angle differences between key network buses to take some protection-control action. This was the principle proposed for the French Defense Plan. It can be safely predicted that with wide scale use of PMUs one would see many more such schemes come into use.

## CONCLUSIONS

Wide area measurement technology has matured. The PMUs are being commercially manufactured by more than a dozen manufacturers throughout the world. This technology offers many advantages over the previously used state estimation techniques. In addition to precise state estimation, this technology offers attractive options for improving protection and control actions on modern power systems. With the nature of power systems changing because of preponderance of renewable sources of energy, open access to the transmission grid, and deregulated industries, it is inevitable that the power systems of the future will have to face more stressful regimes, and in that case improved protection and control offered by the wide area measurement systems based on PMUs will become even more important.

## BIBLIOGRAPHY

- [1] A.G. Phadke, M. Ibrahim, T. Hlibka, "Fundamental Basis for Distance Relaying with Symmetrical Components", IEEE Trans. on PAS, Vol. PAS-96, No. 2, March/April 1977, pp. 635-646.
- [2] Nathan Cohn, "Control of generation and power flow on Interconnected Power Systems", (Book), John Wiley, 1961.
- [3] A.G. Phadke, J. S. Thorp, 2 chapters for "**ADVANCES IN ELECTRIC POWER AND ENERGY CONVERSION SYSTEM DYNAMICS AND CONTROL**", edited by C. T. Leondes
- [4] A.G. Phadke and J.S. Thorp, "**Computer Relaying for Power Systems**", (Book), RSP-John Wiley publishers, 1993.
- [5] R.F. Nuqui and A.G. Phadke "Phasor Measurement Unit Placement Techniques for Complete and Incomplete Observability, IEEE Trans. On Power Delivery, Vol. 20, No. 4, October 2005, pp 2381-2388.
- [6] Niusha Rostamkolai, Ph.D. dissertation, Virginia Tech 1986, "Adaptive Optimal Control of AC/DC Systems.
- [7] N. Rostamkolai, A.G. Phadke, J.S. Thorp, W.F. Long, "Measurement based optimal control of high voltage AC/DC systems", IEEE Trans. on Power Systems, Vol. 3 No. 3, August 1988, pp 1139-1145.
- [8] Edgardo Manansala, Ph.D. dissertation, Virginia Tech August 1989, "Adaptive power system control".
- [9] Edgardo C. Manansala, A.G. Phadke, "An optimal centralized controller with nonlinear voltage control", Electric Machines and Power Systems, 19, 1991, pp 139-156.
- [10] L. Mili, T. Baldwin, A.G. Phadke, "Phasor measurements for voltage and transient stability monitoring and control", Workshop on Application of advanced mathematics to Power Systems, San Francisco, Sept. 4-6, 1991.
- [11] A.F. Snyder, N. Hadjsaid, D. Georges, L. Mili, A.G. Phadke, O. Faucon, S. Vitet, "Inter-area oscillation damping with power system stabilizers and synchronized phasor measurements", PowerCon 1998, China.
- [12] M.A. Smith, "Improved Dynamic Stability Using FACTS devices with phasor measurement feedback", MS Thesis, Virginia Tech, 1994.



**A. G. Phadke (LF 2003)** is a University Distinguished Professor (Emeritus) at Virginia Tech in Blacksburg, Virginia, USA. His primary research area is the microcomputer based monitoring, protection, and control of power systems. He is a co-author of two books on relaying: *Computer Relaying for Power Systems*, and *Power System Relaying*, and is the editor of and contributor to the book *Handbook of Electrical Engineering Computations*. He is a Fellow of IEEE and was awarded the IEEE Third Millennium Medal in 2000, named the Outstanding Power Engineering Educator by the IEEE in 1991, and received the Power Engineering Educator Award of the EEI in 1986. He received the IEEE Herman Halperin Transmission and Distribution award in 2000. He was the Chairman of the Technical Committee of USNC CIGRE, and Editor-In-Chief of IEEE Transactions on Power Delivery. Dr.

Phadke was elected to the US National Academy of Engineering in 1993.

